



---

The Space Congress® Proceedings

2004 (41st) Space Congress Proceedings

---

Apr 27th, 8:00 AM

## Panel Session III - Astronomical Search for Origins Program

Eric P. Smith

*Origins Theme Scientist, James Webb Space Telescope Program Scientist*

Follow this and additional works at: <http://commons.erau.edu/space-congress-proceedings>

---

### Scholarly Commons Citation

Eric P. Smith, "Panel Session III - Astronomical Search for Origins Program" (April 27, 2004). *The Space Congress® Proceedings*. Paper 11.

<http://commons.erau.edu/space-congress-proceedings/proceedings-2004-41st/april-27/11>

This Event is brought to you for free and open access by the Conferences at ERAU Scholarly Commons. It has been accepted for inclusion in The Space Congress® Proceedings by an authorized administrator of ERAU Scholarly Commons. For more information, please contact [commons@erau.edu](mailto:commons@erau.edu).

**EMBRY-RIDDLE**  
Aeronautical University,<sup>™</sup>  
SCHOLARLY COMMONS



# Astronomical Search for Origins Program

Eric P. Smith

Origins Theme Scientist,  
James Webb Space Telescope Program Scientist

27-April-2004

41st Space Congress

1

## Origins Theme's Two Defining Questions

### Where Did We Come From?



#### Tracing Our Cosmic Roots

- Formation of galaxies, stars, heavy elements, planetary systems and ... life on the early Earth

### Are We Alone?

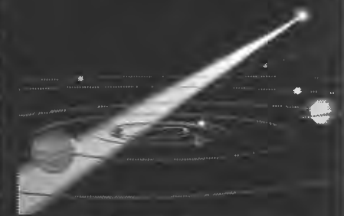

#### Search for Life Outside the Solar system

- Remote detection of biological activities on planets beyond our solar system

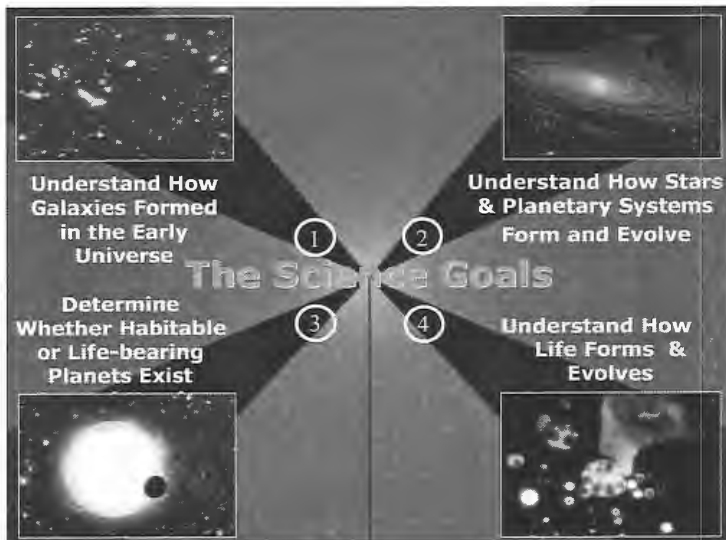

## Understand How the Galaxies Formed in the Early Universe

- Determine the role of gravity in the emergence of galaxies
- Establish how the birth and aging of a galaxy influence the chemical composition that is available to stars, planets, and living organisms



- HST, COBE and WMAP gave us our first hints
- Spitzer and JWST will complete our understanding

## Understand How Stars and Planetary Systems Form and Evolve

- Discover planetary systems forming around young stars
- Characterize the planets and planetary systems around stars



## Determine Whether Habitable or Life-bearing Planets Exist around Nearby Stars

- Determine how common habitable worlds are in the Universe
- Establish how to recognize the signatures of life on other worlds

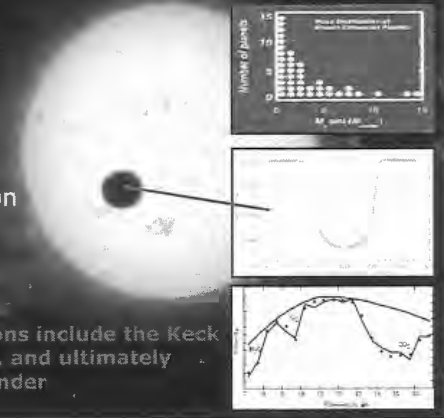

- Key Science missions include the Keck Interferometer, SIM, and ultimately Terrestrial Planet Finder

## Understand How Life Forms & Evolves

- Determine the principles governing the organization of matter into living systems
- Determine limits of life in environments analogous to conditions on other worlds

• Astrobiology research to identification of

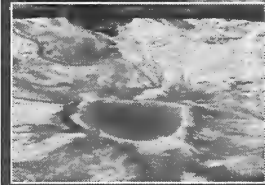

## Origins Program Missions

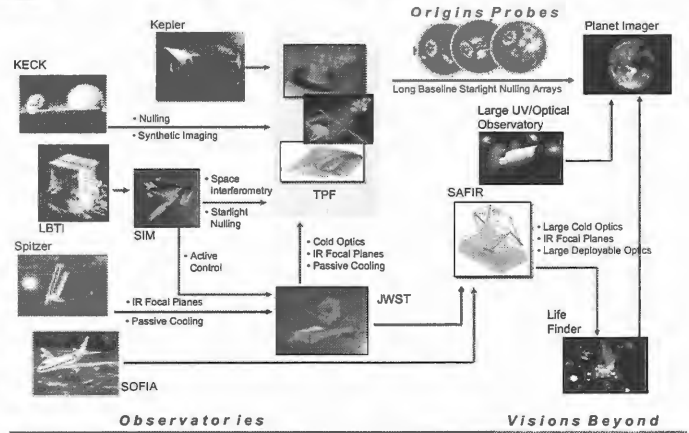

## James Webb Space Telescope (JWST)

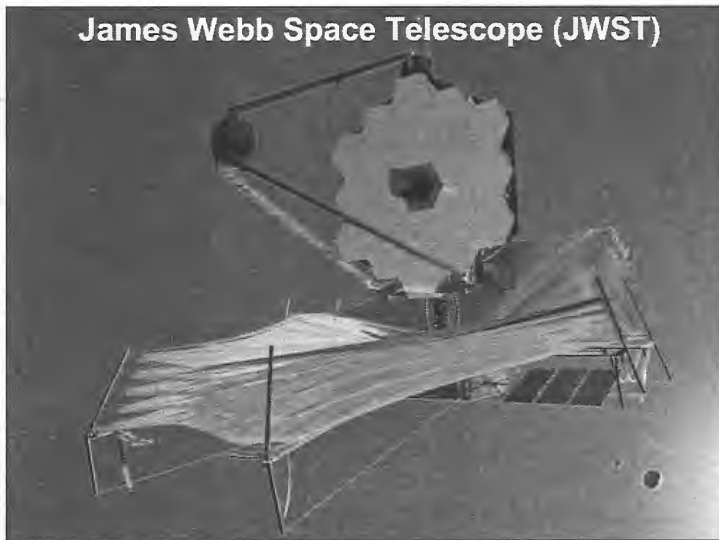

## JWST Overview

- **Mission** (Part of NASA's *Astronomical Search for Origins* theme)
  - Detect light from the first objects in the universe
  - Study of the birth and evolution of galaxies
  - Understand star and planet formation
- **Description**
  - Sensitive (large and cold) infrared (0.6-28 $\mu$ m) space observatory
  - Orbit at Sun-Earth Lagrange Point 2 (L2 - about 1.5 million km from Earth)
  - Launch in 2011
  - 5 year lifetime (10 year goal)
  - ~\$3B total value:
    - ~\$2.5B U.S. (~\$1.9B development + ~\$0.6B ops) + ~\$0.4B equivalent value from ESA + ~\$0.1B equivalent value from CSA [nearest \$0.1B]
- **Organization**
  - Project Lead: NASA's Goddard Space Flight Center
  - International collaboration w/ European and Canadian Space Agencies (ESA & CSA)
  - Prime Contractor: Northrop Grumman Space Technology
  - Other mission hardware & software: University of Arizona, JPL, STScI
- **Status**
  - Preliminary Design (Formulation/Phase B)

27-April-2004

41st Space Congress

10



## JWST Observatory

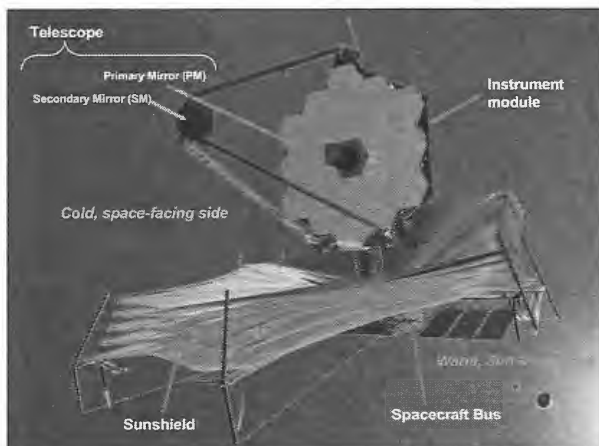

## JWST Animation



27-April-2004

41st Space Congress

12



# Radial Velocity Planet Detection

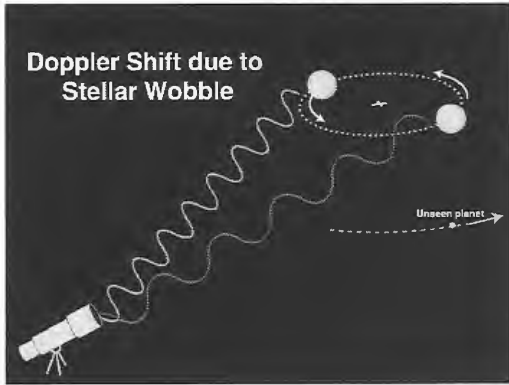

27-April-2004

41st Space Congress

13

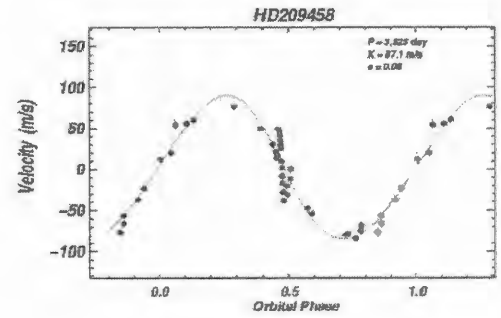

27-April-2004

41st Space Congress

14



# Transits Reveal Planet

- Transits of a planet orbiting HD 209458 determine properties of another Solar System
  - Previously known from radial velocity
  - Inclination= 87.1°
  - Mass= 0.63 M<sub>Jup</sub>
  - Radius = 1.27-1.6 R<sub>Jup</sub>
  - Density= 0.27-0.38 g/cc < Saturn
- Spectroscopy of transit signal can probe planet's atmosphere

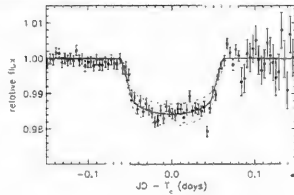
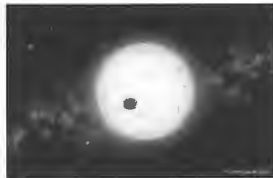

27-April-2004

41st Space Congress

15



# Origins Program Missions

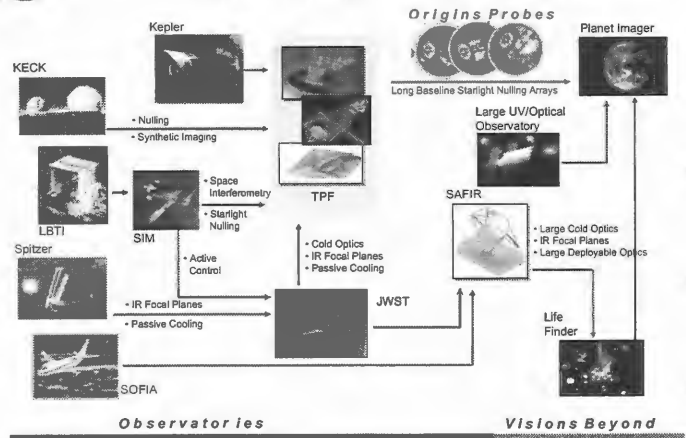

Observatories      Visions Beyond



# The Kepler Mission

Use transit photometry to detect Earth-size planets

- Wide field-of-view 0.95-meter (3-foot) diameter telescope
- Monitor 100,000 stars (every 15 minutes) for 4 years
- Enough precision (20 ppm) to detect transits of Earth-size planets
- Launches 2007

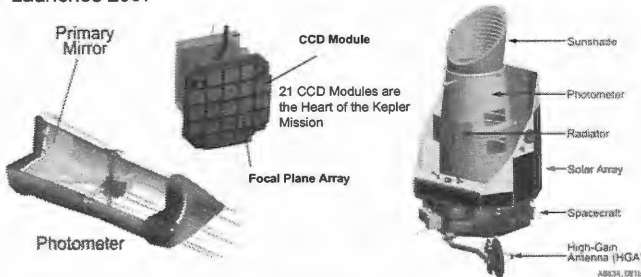

27-April-2004

41st Space Congress

17



# The Kepler Mission

Expected Number of Planetary Discoveries if most Stars have Planets

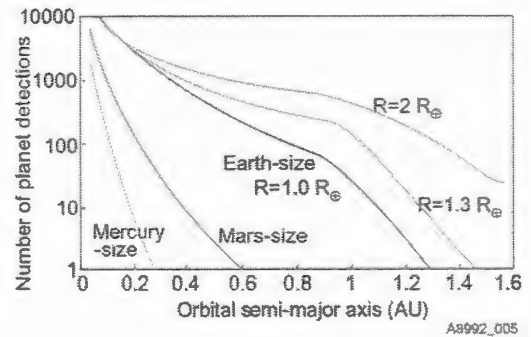

27-April-2004

41st Space Congress

18



## Origins Program Missions

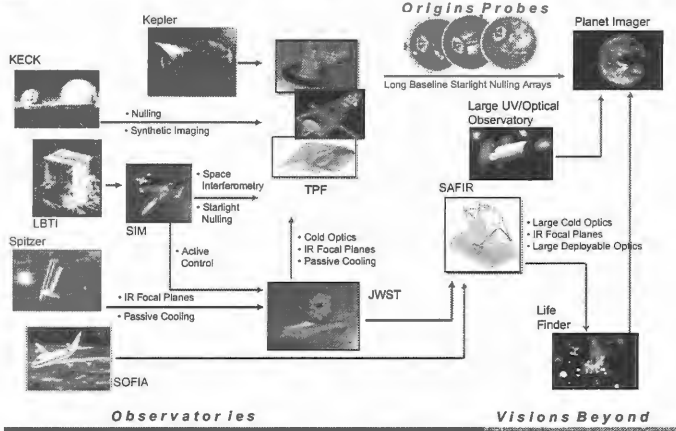

## Space Interferometers: SIM

### Space Interferometer Mission (SIM):

- Use astrometry to find planets orbiting nearby stars
  - From Jupiter's to a few Earth masses
- Carry out general astrometric program
- Demonstrate scientific operation of space interferometry
- Demonstrate TPF technologies and interferometric techniques
- Launch 2009
- 5+ year operation



## Astrometric Search for Planets

- Measure star's positional wobble
  - Complements radial velocity
  - Most sensitive to massive planets far from their stars
- **Space Interferometry Mission** will be able to detect tiny, tiny stellar wobble due to Earth-mass planets around nearby stars
  - Measures positions of stars with precision equivalent to the size of an *amoeba in California as seen from Washington, DC!!*

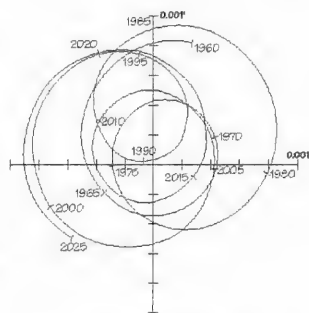

Sun's wobble seen from 33 light-years away

27-April-2004

41st Space Congress

21



## Origins Program Missions

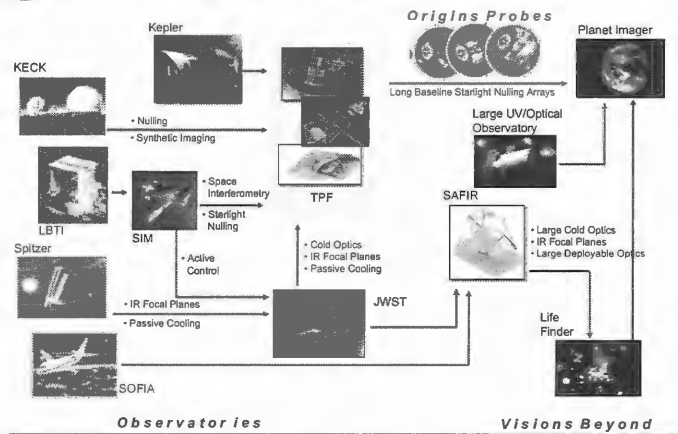

## Terrestrial Planet Finder (TPF)

“Like finding a firefly next to a searchlight on a foggy night”

- Detecting light from planets beyond solar system is hard:
  - Parent star is  $10^6$  to  $10^9$  times brighter
  - Planet within 1 AU of its parent star
- The science goal of TPF: identify terrestrial planets in the habitable zones of ~100-200 nearby stars and to examine the brightest detected planets for signs of life itself



## The Habitable Zone\* for Various Types of Stars

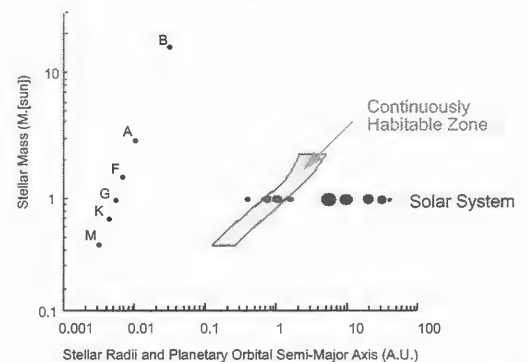

\*The Habitable Zone is the range of distances from a star at which water can remain liquid on the surface of an orbiting planet

27-April-2004

41st Space Congress

24

78



## Simulated TPF Spectrum of an Earth-like Planet

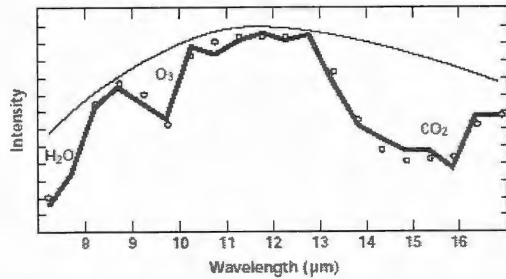

27-April-2004

41st Space Congress

25



## Atmospheric Composition of an Early Earth-like World Harboring Life?

### Main Constituents

CO<sub>2</sub>, N<sub>2</sub>, H<sub>2</sub>O

### Secondary Constituents

CO, H<sub>2</sub>, H<sub>2</sub>S, CH<sub>4</sub>

### Trace Constituents

Organo-sulfur compounds, hydrocarbons, other reduced gases

27-April-2004

41st Space Congress

26



## Origins Science in the New Vision

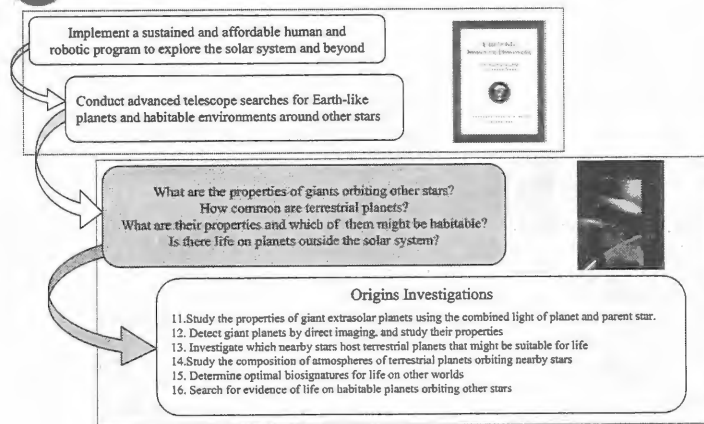

27-April-2004

41st Space Congress

27



## How do Origins Missions Align with the Vision?

Mission	Status	Investigations
HST	Operational	11,23
Keck Interf.	ΦC/D	11,12
LBTI	ΦC/D	11,12
Kepler	ΦB, 2007 launch	11,13
SIM	ΦB, 2009 launch	11,13,14
JWST	ΦB, 2011 launch	11,12
TPF	~ 2014 launch	11,12,13,14,15,16

27-April-2004

41st Space Congress

28



## Changes to Missions in response to the Vision

- **JWST:** project considering white paper study by astrobiologists outlining observatory capabilities for optimal astrobiology science return
- **TPF:** Split TPF program into two components, coronagraphic and interferometric observatories and accelerate development on coronagraphic option.

27-April-2004

41st Space Congress

29



## Why Fly a TPF Coronagraph and an Interferometer?

- Respond to presidents vision - "...conduct advanced telescope searches for Earth-like planets and habitable environments around other stars."
- The technology appears to be maturing for both
- Fly sooner -- A small to moderate sized coronagraph in ~2014
  - Starlight suppression technology must be fully demonstrated first (by 2006)
  - Enter phase A in 2007
- More capable, later --- Formation flying interferometer done jointly with ESA later towards end of decade
  - Continue technology development during coronagraph formulation and implementation
  - Collaboration with ESA on SMART3 (~2011)
  - Enter Phase A in ~2011
- Most compelling science --- Data from both wavelength regions provide robust assessment of habitability and biomarkers
- Doing both within ORIGINS line requires no near term augmentation

27-April-2004

41st Space Congress

30



## ORIGINS Program Status

- Well Aligned with New NASA Vision
  - ORIGINS program already investigating planetary systems today
  - Existing programs adapting to vision
- 2003 was an important year for ORIGINS
  - Both SIM and JWST passed into Phase B and are meeting technology and schedule milestones
- Long Term issues
  - Develop technology program for the large telescopes of a decade from now