

2012

A New Control System for Left Ventricular Assist Devices Based on Patient-specific Physiological Demand

George Faragallah
University of Central Florida

Yu Wan
University of Central Florida

Eduardo Divo
Embry-Riddle Aeronautical University, Eduardo.divo@erau.edu

Marwan Simaan
University of Central Florida

Follow this and additional works at: <http://commons.erau.edu/db-mechanical-engineering>

 Part of the [Mechanical Engineering Commons](#)

Scholarly Commons Citation

Faragallah, G., Wan, Y., Divo, E., & Simaan, M. (2012). A New Control System for Left Ventricular Assist Devices Based on Patient-specific Physiological Demand. *Inverse Problems in Science and Engineering*, 20(5-6). Retrieved from <http://commons.erau.edu/db-mechanical-engineering/22>

On author's personal website or departmental website immediately//On institutional repository or subject-based repository after either 12 months embargo//Publisher's version/PDF cannot be used.

This Article is brought to you for free and open access by the College of Engineering at Scholarly Commons. It has been accepted for inclusion in Department of Mechanical Engineering - Daytona Beach by an authorized administrator of Scholarly Commons. For more information, please contact commons@erau.edu.

A New Control System for Left Ventricular Assist Devices based on Patient-Specific Physiological Demand

George Faragallah^a, Yu Wang^a, Eduardo Divo^{b*}, and Marwan Simaan^a

^a *Department of Electrical Engineering and Computer Science*

University of Central Florida, Orlando, FL

^b *School of Engineering Technology*

Daytona State College, Daytona Beach, FL

Abstract

A Left Ventricular Assist Device (LVAD) is a mechanical pump that helps patients with Heart Failure (HF) condition. This pump works in parallel to the ailing heart and provides a continuous flow from the weak left ventricle to the ascending aorta. The current supplied to the pump motor controls the flow of blood. A new feedback control system is developed to automatically adjust the pump motor current to provide the blood flow required by the level of activity of the patient. The systemic Vascular Resistance (R_S) is the only undeterministic variable parameter in a patient-specific model and also a key value that expresses the level of activity of the patient. The rest of the parameters are constants for a patient-specific model. To determine the level of activity of the patient, an inverse problem approach is followed. The output data (pump flow) is observed and using an optimized search technique, the best model to describe such output is selected. Furthermore, the estimated R_S is used in another patient-specific cardiovascular model that assumes a healthy heart, to determine the blood flow demand. Once the physiological demand is established, the current supplied to the pump motor of the LVAD can be adjusted to achieve the desired blood flow through the cardiovascular system. This process can be performed automatically in a real-time basis using information that is readily available and thus rendering a high degree of applicability. Results from simulated data shows that the feedback control system is fast and very stable.

Keywords: Feedback Control, Cardiovascular Model, LVAD, Physiological Demand, Fibonacci Search.

*Corresponding author. Email: divoe@daytonastate.edu

A. Introduction

The American Heart Association (AHA) estimates that 5.8 million patients above the age of 20 are suffering from Heart Failure (HF) [1], a condition in which the heart cannot pump enough blood into the circulatory system and thus not providing the body with its needs of nutrients and oxygenated blood. This occurs because the heart muscle is not strong enough to push the blood volume stored in the left ventricle to the ascending aorta and from there to the rest of the body. For such patients, heart transplant (HTx) is the best treatment. Patients often wait a long time before a suitable donor heart is available (300 days in average). During this period they require some sort of mechanical support to help the ailing heart perform its functions. The left ventricular assist device (LVAD) is such a device. It is a rotary mechanical pump powered with batteries and connected to a controller that sets the pump speed. This pump can provide an alternative way for the blood to flow with a higher rate between the ventricle and the aorta for HF patients.

At present, the LVAD control is simply a manual setting to regulate the pump to operate a constant speed level that matches the lowest venous return [2]. This technique limits the activity of the patients and prevent their return to workforce and many other forms of life that require the blood flow to be from moderate to high. This would be acceptable if the device is used in bridge to transplant (BTR) therapy. As mentioned above, in BTR therapy the device is only connected for a period of time until the HTx is performed. Nowadays, the LVAD is used as destination therapy (DT) [3] device for patients who do not qualify for HTx due to their age and/or condition [4]. Since the device will have to support the patients for a longer period of time, then it requires an automatic feedback controller that can sense and respond to the needs of the patients for more or less blood flow [6]. By doing so, the controller can manipulate the current signal input to the pump motor, which directly controls the pump flow, to match the physiological need. This controller will allow the patients to leave the hospital and return to a relatively independent and normal lifestyle. Such controller requires real-time measurements of the hemodynamic of the patients. However, under the current state-of-the-art technology the implantation of long-term sensors inside the human heart is not possible due to the vulnerability to thrombus formation over the sensing diaphragm and the extra strain on the batteries used to power both the pump and the controller [5]. External sensors like the ones used in pacemakers are not highly reliable to be used in conjunction with the LVAD. Previous work has been conducted to develop a physiological demand-based controller [9]-[10]; Vollkron et al. [2] used the venous return, the

required level of perfusion, and heart rate to accomplish this. In the work by Wu et al. [7] adaptive control methods were implemented.

The pump flow data seems to be a good candidate to be used to control the pump motor current as it can be easily measured by a flow-meter at one of the pump cannulae [11]. It has been shown that the flow through the pump will change, without any changes to the controller parameters, as a reaction to a change in the level of activity of the patient [14]. The systemic vascular resistance (R_S) is the total resistance offered by the systemic circulation to the blood flow through the body's arterial, bed, and venous return system. It is also an indication of the activity level of the patient; that is, if the R_S is high it means that the patient is at rest, and vice versa. Using this relation, the R_S can be estimated based on the changes that occur in the pump flow. Using inverse problem techniques, the pump flow is observed and using its variations, the R_S is estimated. Since the R_S is the only variable parameter in the model, then the information required to determine the physiological demand of the patient is obtained.

$$Q = G(R_S) \quad (0)$$

Where Q is the pump flow and $G(R_S)$ is the model governing the relation between the pump flow and the systemic vascular resistance.

A Fibonacci search algorithm is used as a one-dimension optimization method to minimize the error of the estimation. The Fibonacci search method was chosen over other one-dimensional optimization schemes because, among other reasons, the number of iterations to arrive at a converged solution can be pre-determined based on a required tolerance [8]. This feature is extremely important in applications such as the one presented herein as the decision process must be quick and accurate, and implemented in real-time.

B. The Cardiovascular Model

The cardiovascular system can be represented by a 5th order circuit model and the LVAD pump can be simulated by a 1st order circuit model. Combining both models will result in a 6th order model that has a minimum number of parameters that can offer enough complexity to give an accurate representation of the heart and the LVAD.

Figure 1 shows the 5th order model of the cardiovascular system. This model is adopted from previous work [12] where every resistance, inductance, capacitance, and diode used in the model is well explained and a standard value is provided in Table 1 for a typical adult.

There is a need, however, to discuss in more details some important elements in this circuit like: R_S which represents the systemic vascular resistance. This particular parameter can be used to simulate the level of activity experienced by the patient, higher value means that the patient is resting and lower value means that the arteries are offering less resistance to the blood flow because of the high level of activity of the patient (like running, exercising, etc.)

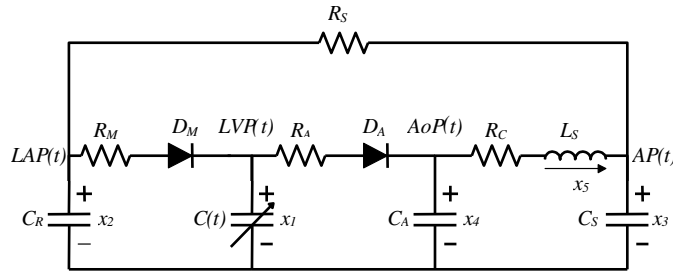

Figure 1: Cardiovascular Circuit model

Table 1: Cardiovascular Model Parameters

Parameters	Value	Physiological Meaning
Resistances (mmHg· s/ml)		
R_S	1.0000	Systemic Vascular Resistance (R_S)
R_M	0.0050	Mitral Valve Resistance
R_A	0.0010	Aortic Valve Resistance
R_C	0.0398	Characteristic Resistance
Compliances (ml/mmHg)		
$C(t)$	Time-varying	Left Ventricular Compliance
C_R	4.4000	Left Atrial Compliance
C_S	1.3300	Systemic Compliance
C_A	0.0800	Aortic Compliance
Inertances (mmHg· s ² /ml)		
L_S	0.0005	Inertance of blood in Aorta

The left ventricular compliance $C(t)$ is the inverse of the elastance function of the heart $C(t) = 1/E(t)$. The elastance represents the contractual state of the left ventricle. It relates to the ventricle's pressure and volume according to the following expression:

$$E(t) = \frac{LVP(t)}{LVV(t) - V_0} \quad (1)$$

Where $LVP(t)$ is the left ventricular pressure, $LVV(t)$ is the left ventricular volume, and V_0 is a reference volume, which corresponds to the theoretical volume in the ventricle at zero pressure. The elastance function $E(t)$ can be approximated mathematically. In our work we use the expression:

$$E(t) = (E_{\max} - E_{\min})E_n(t_n) + E_{\min} \quad (2)$$

Where $E(t)$ represents the elastance of the heart as shown in Figure 2. $E_n(t_n)$ is the normalized elastance (also called “double hill” function) represented by the expression:

$$E_n(t_n) = 1.55 \cdot \left[\frac{\left(\frac{t_n}{0.7}\right)^{1.9}}{1 + \left(\frac{t_n}{0.7}\right)^{1.9}} \right] \cdot \left[\frac{1}{1 + \left(\frac{t_n}{1.17}\right)^{21.9}} \right] \quad (3)$$

In the expression above, $E_n(t_n)$ is the normalized elastance, $t_n = t/T_{\max}$, $T_{\max} = 0.2 + 0.15t_c$ and t_c is the cardiac cycle interval, i.e., $t_c = 60/\text{HR}$, where HR is the heart-rate. Notice that $E(t)$ is a rescaled version of $E_n(t_n)$ and the constants E_{\max} and E_{\min} are related to the end-systolic pressure volume relationship (ESPVR) and the end-diastolic pressure volume relationship (EDPVR) respectively. Figure 2 shows a plot of $E_H(t)$ for a healthy heart with $E_{\max} = 2$ mmHg/ml and $E_{\min} = 0.06$ mmHg/ml, and a heart-rate of 60 beats per minute (bpm). For a heart with cardiovascular disease, the elastance expression used in our model is scaled using the value of E_{\max} which can be varied from 1 mmHg/ml to 0.25 mmHg/ml to represent mild to severe heart failure, respectively.

D_A and D_M are the ideal diode representations of the aortic and mitral valves. The opening and closing of these valves are controlled by the pressures across them. They are used to simulate the dynamics of the two valves and hence the four phases of the cardiac cycle, mentioned in Table 2, are achieved.

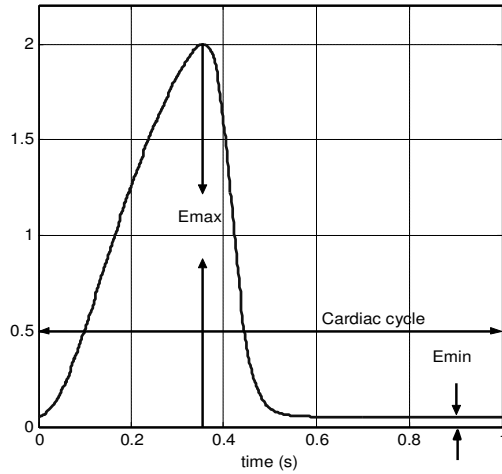

Figure 2: Elastance function $E(t)=1/C(t)$ of a healthy heart. (Cardiac Cycle =60/HR)

Table 2: Phases of the cardiac cycle

Modes	Valves		Phases
	Mitral	Aortic	
1	closed	closed	Isovolumic relaxation
2	open	closed	Filling
1	closed	closed	Isovolumic contraction
3	closed	open	Ejection
-	open	open	Not feasible

C. The combined LVAD-Cardiovascular model

The LVAD pump can be modeled as a 1st order system. When added to the 5th order model in Figure 1 the result will be a 6th order model that is shown in Figure 3. The pump functions in parallel to the heart of the patient, hence the parallel connection of the LVAD pump between the left ventricle and the aorta. Table 3 indicates the six state variables for this circuit model.

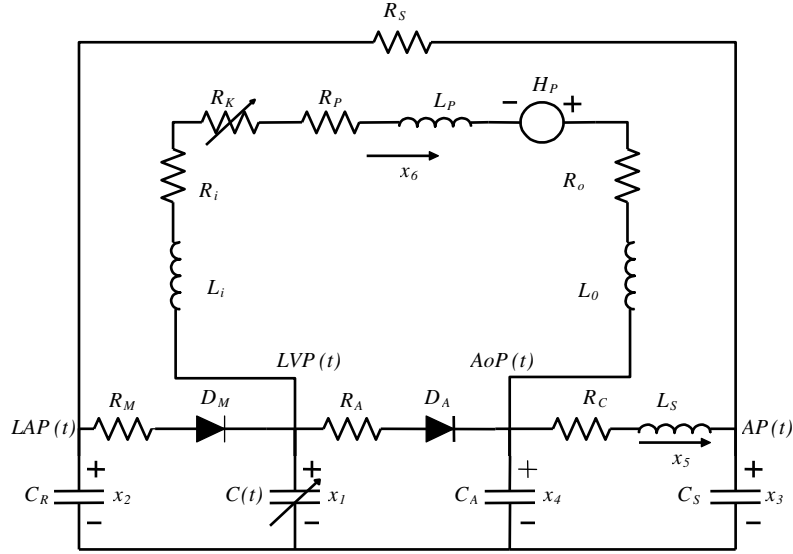

Figure 3: Combined Cardiovascular and LVAD model

Table 3: State variables in the cardiovascular model

Variables	Name	Physiological meaning (units)
$x_1(t)$	$LVP(t)$	Left ventricle pressure (mmHg)
$x_2(t)$	$LAP(t)$	Left atrial pressure
$x_3(t)$	$AP(t)$	Arterial pressure (mmHg)
$x_4(t)$	$AoP(t)$	Aortic pressure (mmHg)
$x_5(t)$	$Q_T(t)$	Total flow (ml/s)
$x_6(t)$	$Q_P(t)$	Pump flow (ml/s)

The LVAD considered in this paper is a rotary mechanical pump connected with two cannulae between the left ventricle and the aorta. The LVAD pumps blood continuously from the left ventricle into the aorta. The pressure difference between the left ventricle and the aorta is characterized by the following relationship:

$$LVP(t) - AoP(t) = R_i Q + L_i \frac{dQ}{dt} + R_o Q + L_o \frac{dQ}{dt} + R_p Q + L_p \frac{dQ}{dt} - H_p + R_k Q \quad (4)$$

In the expression above H_p is the pressure (head) gain across the pump and Q is the blood flow rate through the pump. The parameters, R_i , R_o , and R_p represent the flow resistances and L_i , L_o , and L_p represent the flow inertances of the cannulae and pump respectively. Values for these parameters are shown in Table 4.

Table 4: Parameter Values in LVAD Model

Parameters	Value	Physiological Meaning
Cannulae Resistances (mmHg.s/ml)		
R_i	0.0677	Inlet Cannula Resistance
R_p	0.17070	Pump Resistance
R_o	0.0677	Outflow Cannula Resistance
Cannulae Inertances (mmHg.s ² /ml)		
L_i	0.0127	Inlet Cannula Inertance
L_p	0.02177	Pump Inertance
L_o	0.0127	Outflow Cannula Inertance

The nonlinear time-varying resistance R_k in (6) has the form:

$$R_k = \begin{cases} 0 & \text{if } LVP(t) > \bar{x}_1 \\ \alpha(LVP(t) - \bar{x}_1) & \text{if } LVP(t) \leq \bar{x}_1 \end{cases} \quad (5)$$

R_k is included in the model to characterize the phenomenon of suction. R_k is zero when the pump is operating normally and is activated when $LVP(t)$ (x_1) becomes less than a predetermined small threshold \bar{x}_1 , a condition that represents suction. The value of R_k when suction occurs increases linearly as a function of the difference between $LVP(t)$ and \bar{x}_1 . The parameter α is a cannula-dependent scaling factor. The values used for the suction parameters are $\alpha = -3.5$ s/ml and $\bar{x}_1 = 1$ mmHg.

The pressure gain across the pump H_p is modeled using the direct relation between the electric power supplied to the pump motor P_e and the hydrodynamic power generated by the pump P_p scaled by the pump efficiency η as $P_p = \eta P_e$. Furthermore, the electric power may be written in terms of the supplied voltage V and the supplied current $i(t)$ to the pump motor as $P_e = V \cdot i(t)$, while the hydrodynamic power may be written in terms of the pump head or pressure gain H_p and the pump flow Q as $P_p = \rho g H_p Q$ where ρ is the density of the reference fluid and g is the acceleration of gravity ($\rho_{Hg} = 13,600$ kg/m³, $g = 9.8$ m/s²). Combining these expressions yields:

$$H_p = \frac{\eta V}{\rho g} \cdot \frac{i(t)}{Q} \quad (6)$$

Or:

$$H_p = \gamma \frac{i(t)}{Q} \quad (7)$$

Where $\gamma = \eta V / \rho g$. For a typical LVAD, after applying the appropriate conversion factors and assuming a pump motor supplied voltage $V = 12$ volt as well as a pump efficiency of 100% (assuming that most losses are accounted for by the pressure losses induced by R_p and L_p), the constant γ can be computed to be $\gamma = 89,944$ mmHg · ml/s · amp .

Substituting (7) in (4) we obtain the nonlinear state equation governing the behavior of the LVAD as:

$$LVP(t) - A_oP(t) = R^*Q + L^* \frac{dQ}{dt} - \gamma \frac{i(t)}{Q} \quad (8)$$

Where $R^* = R_i + R_o + R_p + R_k$ and $L^* = L_i + L_o + L_p$. Note that it is important to validate the numerical solution when expression (8) is used by ensuring that the system does not allow for operation at zero pump flow $Q(t)$ at any point during the cardiac cycle since equation (8) exhibits its nonlinearity with the pump flow $Q(t)$ in the denominator.

When combined with the model of the left ventricle, the LVAD state equation model in (8) will yield a model that is controlled by the pump motor current $i(t)$ as desired. Furthermore, using the relation between the pump pressure H_p and the pump speed $\omega(t)$ [11]:

$$H_p = \beta \omega^2(t) \quad (9)$$

An expression for the pump speed in terms of the pump motor current can then be derived as follows:

$$\omega(t) = \sqrt{\frac{\gamma i(t)}{\beta Q(t)}} \quad (10)$$

Here $\beta = 9.9025 \cdot 10^{-7}$ mmHg/rpm². Note that it is now clear how the heart hemodynamic through $Q(t)$ influence directly, in a highly nonlinear manner, the pump speed $\omega(t)$.

The state space representation of the combined model can then be written in the following form:

$$\dot{x} = A(t) x + P(t) p(x) + b i(t) \quad (11)$$

Where:

$$A = \begin{bmatrix} \frac{-\dot{C}(t)}{C(t)} & 0 & 0 & 0 & 0 & \frac{-1}{C(t)} \\ 0 & \frac{-1}{R_S C_R} & \frac{1}{R_S C_R} & 0 & 0 & 0 \\ 0 & \frac{1}{R_S C_S} & \frac{-1}{R_S C_S} & 0 & \frac{1}{C_S} & 0 \\ 0 & 0 & 0 & 0 & \frac{-1}{C_A} & \frac{1}{C_A} \\ 0 & 0 & \frac{-1}{L_S} & \frac{1}{L_S} & \frac{-R_C}{L_S} & 0 \\ \frac{1}{L^*} & 0 & 0 & \frac{-1}{L^*} & 0 & \frac{-R^*}{L^*} \end{bmatrix} \quad (12)$$

And:

$$P(t) = \begin{bmatrix} \frac{1}{C(t)} & \frac{-1}{C(t)} \\ \frac{-1}{C_R} & 0 \\ 0 & 0 \\ 0 & \frac{1}{C_A} \\ 0 & 0 \\ 0 & 0 \end{bmatrix}, \quad p(x) = \begin{bmatrix} \frac{1}{R_M} r(x_2 - x_1) \\ \frac{1}{R_A} r(x_1 - x_4) \end{bmatrix}, \quad b = \begin{bmatrix} 0 \\ 0 \\ 0 \\ 0 \\ 0 \\ \frac{\gamma}{L^* x_6} \end{bmatrix} \quad (13)$$

Where the $r(\xi)$ in $p(x)$ expression is defined by:

$$r(\xi) = \begin{cases} \xi & \text{if } \xi \geq 0 \\ 0 & \text{if } \xi < 0 \end{cases} \quad (14)$$

D. Development of a Feedback Control

The aim of the feedback controller is to adjust the LVAD speed to provide the required amount of blood flow depending on the level of activity of the patient. The current technology does not allow the implantation of sensors inside the human heart for long-term applications; hence there is a need to depend on the pump flow, which is accessible through the installation of a flow-meter sensor inside the pump cannulae, as a feedback variable to automatically adjust and control the pump motor current which in turns controls the pump speed.

The results shown in Figure 4 are obtained by simulation (using the 6th order model presented above) and reveal that the mean pump flow decreases as the systemic vascular

resistance (R_S) increases while maintaining the pump motor current constant, see [14]. Furthermore, this shows that the pump flow signal can be used as an input variable to estimate the patient's systemic resistance as well as to adjust the pump motor current to achieve a mean pump flow that satisfies the patient's physiological demand. Figure 5, shows how the mean pump speed is increased spontaneously as the R_S increases and that's due to (10) where you can see the pump flow $Q(t)$ being the reciprocal for $\omega(t)$.

A block diagram for the proposed feedback controller is shown in Figure 6. The controller consists of four stages of data acquisition, decision making, estimation, and adjustment of the pump motor current. During the first stage, labeled "detect change in pump flow", the mean pump flow signal is continuously read until a change is detected. This change is evidence that the activity level of the patient has changed and there is a need to adjust the pump motor current to respond to the new physiological demand. The first stage can be thought of as a gate to the rest of the feedback controller blocks. The controller will only work if the first block sends a signal as a response to a change in the mean pump flow.

During the second stage, labeled "Estimate the R_S using the 6th order model", the new R_S is estimated by adjusting the numerical value of R_S in the 6th order model until the resulting mean pump flow (x_6) matches the mean pump flow read in the previous stage. This is accomplished by setting the problem up as an optimization problem aimed at minimizing an objective function formulated as the absolute value of the difference between these mean pump flows. Details of this approach are provided in the next section.

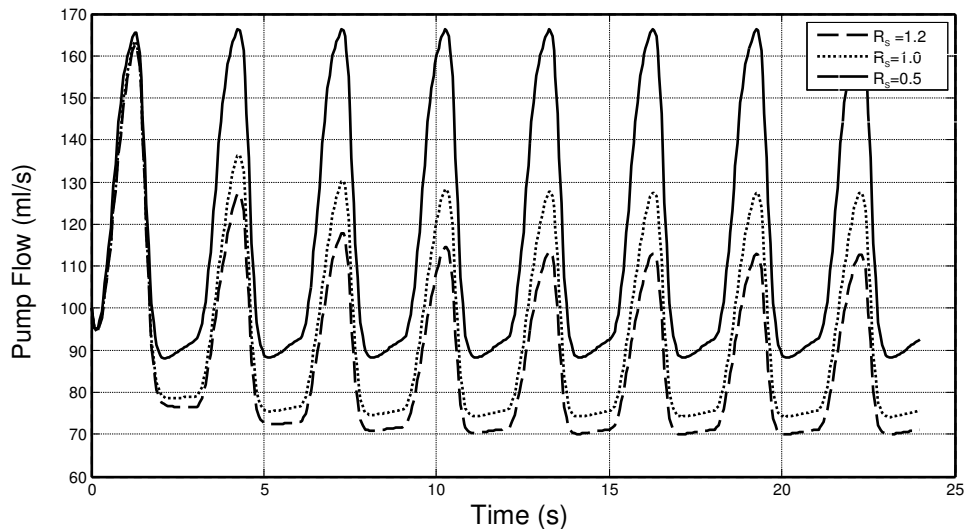

Figure 4: Pump flow signals at $i(t) = 0.18 \text{ amp}$ for different R_S values

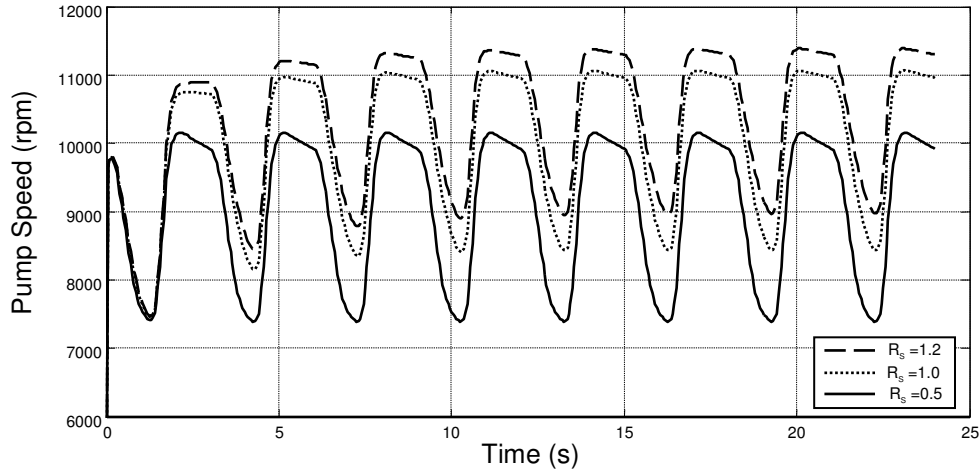

Figure 5: Pump speed signals at $i(t) = 0.18 \text{ amp}$ for different R_S values

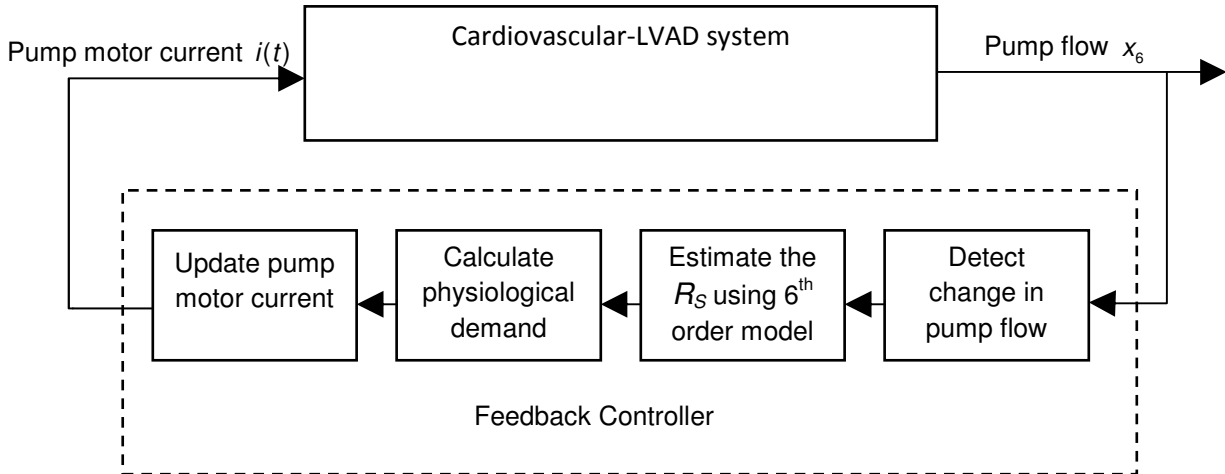

Figure 6: Block diagram for the LVAD feedback controller

During the third stage, labeled “Calculate physiological demand for estimated R_S ”, the physiological demand or required mean pump flow under the current activity level is determined by imposing the value of R_S found during the previous stage into the 5th order model with $E_{\max} = 2 \text{ mmHg/ml}$ to represent a healthy heart. This is done since the overall objective of the controller is to determine the actual output of a healthy heart under the current level of activity, characterized by the estimated R_S , and try to match it with the LVAD.

During the fourth stage, labeled “Update Pump Motor Current”, the pump motor current $i(t)$ will be adjusted until the mean pump flow reaches the physiological demand for the current level of activity calculated in the previous stage. Again, this requires an optimization approach aimed

at reducing an objective function formulated as the absolute value of the difference between the physiological demand and the adjusted mean pump flow. This process is detailed in the next section.

E. Methodology and Results

As discussed in the previous section, the change in the mean pump flow while the control parameters are fixed is an indication of a change in the level of activity of the patient (change in R_S). This requires the estimation of the new R_S for the patient which can be accomplished using a one-dimensional search algorithm. The Fibonacci search algorithm was chosen for this purpose because of its inherent advantage of having a predefined number of iteration before a solution is obtained. The number of iterations is based on the level of accuracy (error tolerance) chosen for the application. The following objective function is to be minimized:

$$J_{\min}(R_S) = \left| \bar{Q}_N - \hat{Q}_P(R_S) \right| \quad (15)$$

Here, \hat{Q}_P is the mean pump flow produced by the estimated R_S (R_S) and \bar{Q}_N is the target mean pump flow caused by the change of activity.

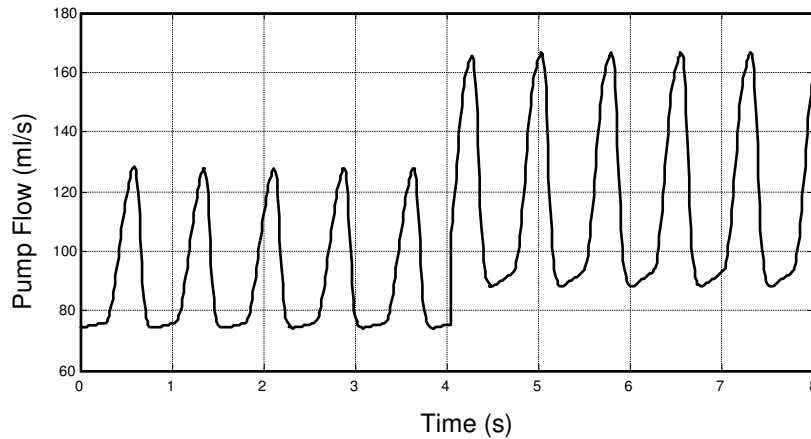

Figure 7: Pump flow signal as R_S changes from 1 to 0.5

Figure 7 shows a simulation of a patient initially at rest who then becomes more physically active. This simulation is modeled by a change in R_S from 1 mmHg.s/ml to 0.5 mmHg.s/ml.

The Fibonacci search was then used to minimize the objective function in (15) to estimate this change in R_S . The number of iterations required to arrive at a converged solution was predetermined based on both the possible range of R_S s and the tolerance required; the former

is assumed to be between 0.4 and 1.4 mmHg.s/ml (this is the range of possible values of R_S) while the latter was established as 0.01 mmHg.s/ml (accepted tolerance for such application). Hence:

$$F_n > \left(\frac{1.4 - 0.4}{0.01} \right) = 100 \Rightarrow F_{11} = 144 > 100 \Rightarrow n = 11 \quad (16)$$

Here, the number of required iterations, n , is determined as the n^{th} Fibonacci number larger than the search range divided by the tolerance. In this case, the 11^{th} Fibonacci number satisfies this criterion.

The Fibonacci search algorithm is then executed evaluating the objective function in (15) by running the 6th order model with each of the iterative estimates of R_S . The search bracket is narrowed down at every iteration step until the convergence criterion is met after the n^{th} iteration. This process is shown in Figure 8.

Although the search interval was originally set for values of R_S between 0.4 and 1.4 mmHg.s/ml, prior knowledge of the system could allow to have started from a narrower interval. That is, it could have been assumed a priori that the increase in mean pump flow signal was evidence of a decrease in R_S and therefore start with a bracket between 0.4 and 1.0 mmHg.s/ml instead, for example, leading to a smaller number of required iterations.

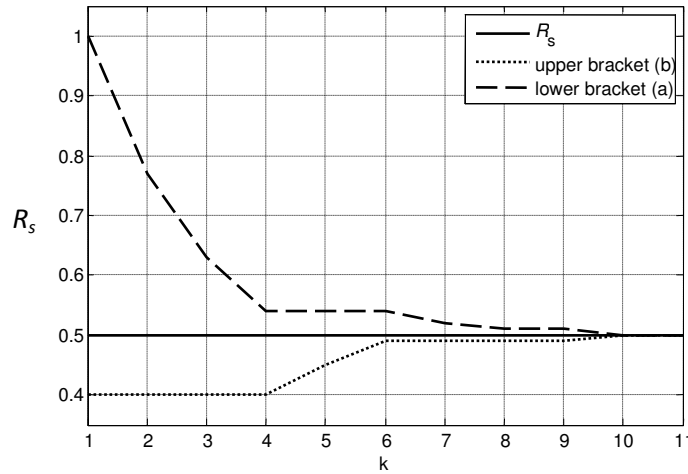

Figure 8: Lower and upper brackets of the Fibonacci search converging to the estimate of R_S

Once the R_S is estimated, a similar approach is then used to adjust the pump motor current to provide the physiological demand. The objective function to be minimized in this case is:

$$f_{\min}(i_p) = |CO - \hat{Q}_p(i_p)| \quad (17)$$

Where CO (cardiac output) is the patient's physiological demand estimated by running the 5th order model for a healthy heart ($E_{\max}=2$) with the estimated value of R_S from the previous minimization process ($R_S=0.5$ mmHg.s/ml in this case), and $\hat{Q}_p(i_p)$ is the mean pump flow provided by the iterative estimate of the pump motor current i_p .

For the case being implemented herein, the physiological demand (CO) was found to be 148.9 ml/s, larger than the current pump flow of 115.3 ml/s achieved by a pump motor current of 0.1 amp, therefore, an increase of the pump motor current is necessary to achieve the goal of meeting the physiological demand. The initial bracket for the pump motor current was then established between 0.1 amp and 0.65 amp while a tolerance of 0.01 amp was set, leading to a predetermined number of 10 iterations to reach convergence. Figure 9 shows the evolution of the i_p bracket throughout the Fibonacci search algorithm.

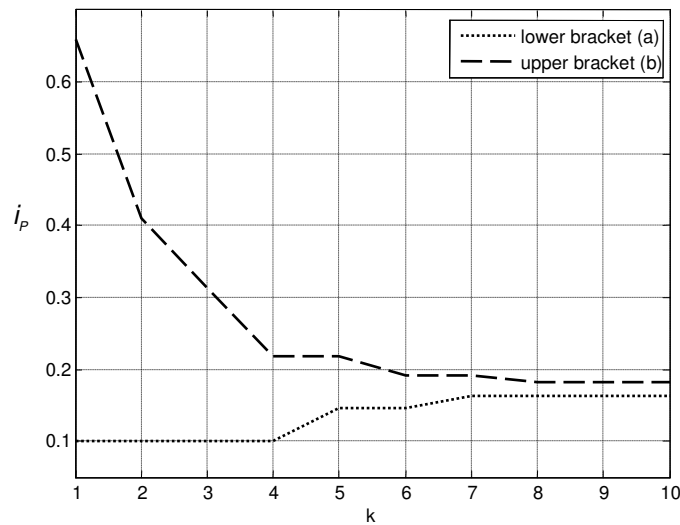

Figure 9: Upper and lower brackets of the Fibonacci search converging to the estimate of i_p

F. Conclusions

A new feedback control system is formulated in this paper to automatically adjust the pump motor current of a Left Ventricular Assist Device (LVAD) to provide the blood flow required by the current level of activity of the patient. This is accomplished by first estimating the systemic vascular resistance (R_S) of the patient from a coupled LVAD-Cardiovascular model using information from measured LVAD pump flow. Furthermore, the estimated R_S is used in a patient-specific cardiovascular model that assumes a healthy heart, to determine the demand in terms of blood flow. Once the physiological demand is established, the current supplied to the pump motor of the LVAD can be adjusted to achieve the desired blood flow through the cardiovascular system. This process can be performed automatically in a real-time basis using information that is readily available and thus rendering a high degree of applicability. Results from simulated data shows that the feedback control system is fast and very stable.

G. Acknowledgment

This work was supported in part by the US National Science Foundation under grant ECCS-0701365.

H. References

- [1] Lloyd-Jones D, Adams RJ, Brown TM, Carnethon M, Dai S, De Simone G, Ferguson TB, Ford E, Furie K, Gillespie C, GO A, Greenlund K, Haase N, Hailpern S, Ho PM, Howard V, Kissela B, Kittner S, Lackland D, Lisabeth L, Marelli A, McDermott MM, Meigs J, Mozaffarian D, Mussolino M, Nichol G, Roger VL, Rosamond W, Sacco R, Sorlie P, Stafford R, Thom T, Wasserthiel-Smoller S, Wong ND, Wylie-Rosett J., "Heart disease and stroke statistics – 2010 update: a report from the American Heart Association," *Circulation*, 2010;121:e46-e215.
- [2] Vollkron M., Schima H., Huber L., Benkowski B., Morello G., and Wieselthaler G., "Control of implantable axial blood pumps based on physiological demand," *Proceedings of the 2006 American Control Conference*, Minneapolis, MN, USA, June 14-16, 2006.

- [3] Park S.J. et al., "Left Ventricular Assist Devices as Destination Therapy: A New Look at Survival," *The Journal of Cardiopulmonary Support and Physiology*, 2005, Vol. 129 No. 1, pp.9-17.
- [4] Carr C.M., Jacob J., Park S.J., Karon B.L., Williamson E.E. and Araoz P.A. "CT of Left Ventricular Assist Devices," *RadioGraphics* 2010; 30:429-444.
- [5] Bertram C D, "Measurement for implantable rotary blood pumps," *Physiological Measurements*, 2005, 26, R99-R117.
- [6] Olsen D.B., "The history of continuous-flow blood pumps," *Artificial Organs*, 2000, 24(6):401-404.
- [7] Wu Y., Allaire P., Tao G. and Olsen D. "Modeling, Estimation and Control of Cardiovascular Systems With a Left Ventricular Assist Device," *Proceeding of American Control Conference 2005*: 3841 - 3846 .
- [8] Dunlap R.A. "The Golden Ratio and The Fibonacci Numbers," *World Scientific Publishing Co. Pte. Ltd., Singapore*, 1st Edition, 1997, ISBN: 9810232640.
- [9] Saito I, Ishii K, Isoyama T, Ono T, Nakagawa H, Shi W, Inoue Y and Abe Y., " Preliminary Study of Physiological Control for the Undulation Pump Ventricular Assist Device," *Proceedings of the International Conference of IEEE EMBS, Buenos Aires, Argentina*, 2010.
- [10] Giridharan G., Pantalos G., Koenig S, Gillars and Skliar M, "Achieving Physiological Perfusion with Ventricular Assist Devices: Comparison of Control Strategies," *Proceedings of 2005 American Control Conference, Portland, OR*, 2005.
- [11] Simaan M.A., Ferreira A., Chen S., Antaki J. F. and Galati, D. G. " A Dynamical State Space Representation and Performance Analysis of a Feedback-Controlled Rotary Left Ventricular Device," *IEEE Trans. On Control Systems Technology*, Vol. 17, No. 1, 2009, pp 15-28.

- [12] Faragallah G., Wang Y., Divo E. and Simaan M.A. "A New Current-Based Control Model of the Combined Cardiovascular and Rotary Left Ventricular Assist Device," Proceeding of 2011 American Control Conference, San Francisco, CA, USA, June 29 – July 1, 2011.
- [13] Simaan M., Faragallah G., Wang Y. and Divo E. "New Aspects of ventricular assist devices." Edited by: Guillermo Reyes, InTech, August 2011, ISBN: 978-953-307-676-8
- [14] Akimoto T., Yamazaki K., Litwak K.N., Tagusari O., Mori T., Antaki J.F., Kameneva M.V., Watach M.J., Umezu M., Tomioka J., Kormos R.L., Koyanagi H. and Griffith B.P. "Rotary blood pump flow spontaneously increases during exercise under constant pump speed: results of a chronic study," *Artificial Organs* 1999 Aug; 23(8):797-801.